

## StormKeeper SK180

The StormKeeper family of products are the highest quality and structurally sound stormwater chambers available on the market. The StormKeeper family of chambers are designed utilizing the most sophisticated and comprehensive techniques to meet the stringent AASHTO LRFD and ASTM requirements. Intended for use under traffic and nontraffic areas, StormKeeper provides a truly cost-effective and structurally superior system to provide underground stormwater storage saving valuable land and protecting the environment.



### StormKeeper SK180

#### Nominal Dimensions

Size (L x W x H)	88.7" x 77.8" x 45.5"
Chamber Storage	113.6 cf
Min. Installed Storage	180.0 cf
Weight	127 lbs

### StormKeeper SK180 End Caps

#### Nominal Dimensions

Size (L x W x H)	24.0" x 78.5" x 44.7"
End Cap Storage	15.3 cf
Min. Installed Storage	53.9 cf
Weight	52 lbs

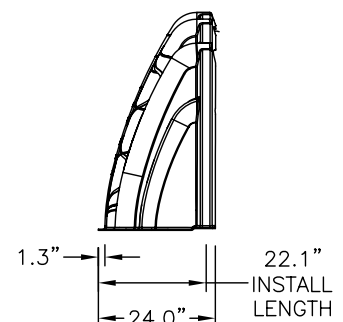
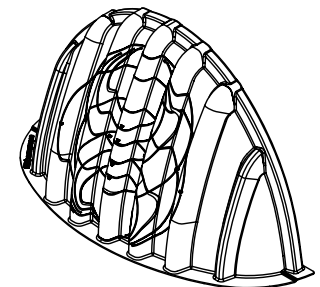
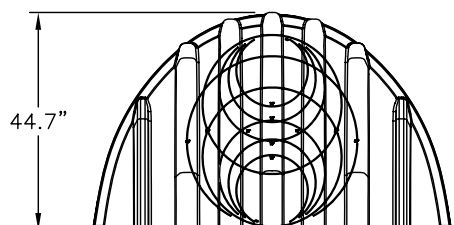
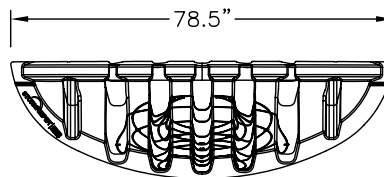
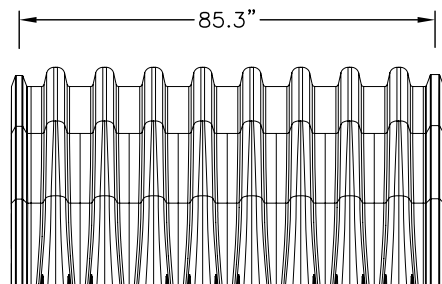
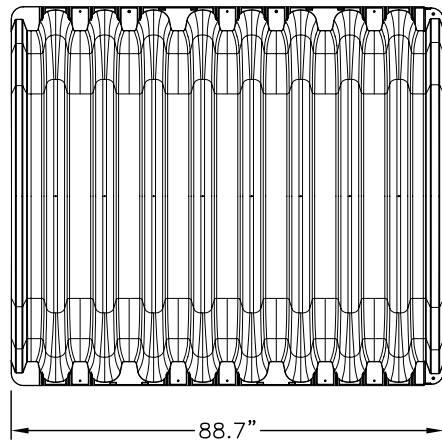

### Shipping

#### Nominal Dimensions

- 17 chambers per pallet
- 12 end caps per pallet
- 8 pallets per truck

# StormKeeper SK180

## Volume of Excavation Required Per Chamber/End Cap

	Stone Bedding Depth			
	9"	12"	15"	18"
StormKeeper SK180	11.4 cy	11.8 cy	12.3 cy	12.8 cy
StormKeeper SK180 End Cap	4.5 cy	4.7 cy	4.9 cy	5.1 cy

Assumes 8" of separation between chamber rows, 12" of perimeter in front of end caps, and 18" of cover minimum. Should depth of cover exceed 18" the volume of excavation will increase accordingly.

## Storage Volume Per Chamber/End Cap

	Chamber Volume Only	Chamber and Stone Volume Stone Bedding Depths			
		9"	12"	15"	18"
StormKeeper SK180	113.6 cf	180.0 cf	185.0 cf	190.1 cf	195.2 cf
StormKeeper SK180 End Cap	15.3 cf	53.9 cf	55.9 cf	58.0 cf	60.0 cf

Assumes 11.5" of stone above chambers, 8" of stone between chambers and 40% stone porosity. End cap volume assumes 12" of perimeter stone.

## Amount of Stone Per Chamber/End Cap

	Stone Bedding Depth			
	9"	12"	15"	18"
StormKeeper SK180	6.1 cy	6.6 cy	7.1 cy	7.6 cy
StormKeeper SK180 End Cap	3.6 cy	3.8 cy	3.9 cy	4.1 cy

Assumes 11.5" of stone above, 8" row spacing, and 12" of perimeter stone in front of the end caps.

## Stage vs. Storage for StormKeeper SK180

Depth (in)	Chamber Volume (cf)	Installed Volume (cf)	Depth (in)	Chamber Volume (cf)	Installed Volume (cf)
1	0.00	1.69	34	79.47	105.28
2	0.00	3.39	35	82.14	108.58
3	0.00	5.08	36	84.74	111.83
4	0.00	6.78	37	87.28	115.05
5	0.00	8.47	38	89.76	118.23
6	0.00	10.16	39	92.16	121.37
7	0.00	11.86	40	94.50	124.47
8	0.00	13.55	41	96.75	127.51
9	0.00	15.25	42	98.93	130.51
10	3.55	19.07	43	101.01	133.45
11	7.06	22.87	44	103.00	136.34
12	10.55	26.66	45	104.87	139.16
13	14.01	30.43	46	106.63	141.91
14	17.45	34.19	47	108.25	144.58
15	20.85	37.92	48	109.71	147.15
16	24.23	41.64	49	110.98	149.60
17	27.58	45.35	50	112.01	151.91
18	30.90	49.03	51	112.63	153.98
19	34.19	52.70	52	113.08	155.94
20	37.45	56.35	53	113.39	157.82
21	40.68	59.99	54	113.57	159.63
22	43.89	63.61	55	113.57	161.32
23	47.06	67.20	56	113.57	163.01
24	50.19	70.77	57	113.57	164.71
25	53.30	74.33	58	113.57	166.40
26	56.37	77.87	59	113.57	168.10
27	59.41	81.39	60	113.57	169.79
28	62.40	84.88	61	113.57	171.49
29	65.37	88.35	62	113.57	173.18
30	68.29	91.80	63	113.57	174.87
31	71.16	95.21	64	113.57	176.57
32	73.98	98.60	65	113.57	178.26
33	76.75	101.96	66	113.57	179.96

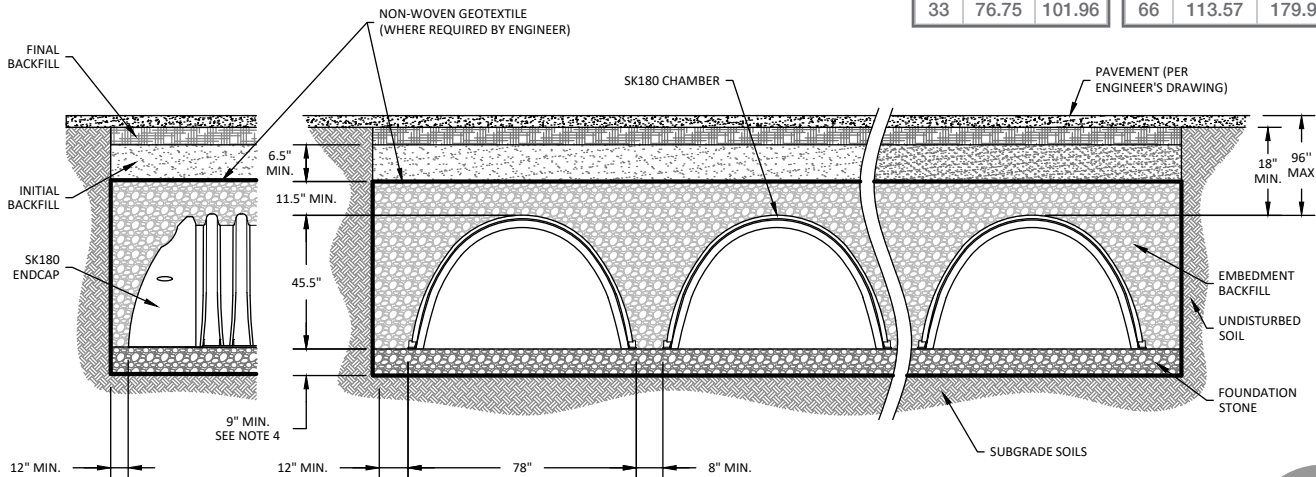

### MANUFACTURER'S WARRANTY

Lane ensures, certifies and documents that SK180 StormKeeper Stormwater Chambers shipped to the job site meets the above claims and standards, and warrants the product is free of any material or workmanship defects.



Lane Enterprises, Inc.  
 275 Grandview Ave, Suite 300  
 Camp Hill, PA 17011  
 P: 717.761.8175 • F: 717.761.5055  
[lane-enterprises.com/StormKeeper](http://lane-enterprises.com/StormKeeper)